

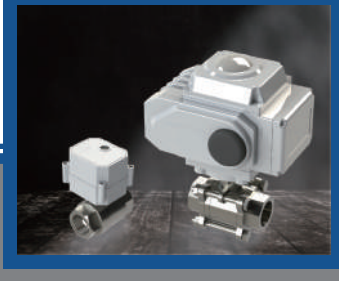

TXMC



## GENERAL KNOWLEDGE

### General Instruction for Electric actuator

For your own safety, please read the instruction below before you inquiring / using our products.

#### Wiring

ST Series. When use DC24V power. No need to partition anode and cathode.

- Wiring project should carry on by the qualified electric engineer according to the electrical facility technique standard.
- It forbids to do wiring project in rainy day or in high humidity.
- Please confirm wiring connection drawing correct connection.
- This device have special cable, no need interior wiring.
- No-opening the top cover ( already have cables ).
- When electrifying, absolutely forbid to connect the opening and closing switch at the same time.
- When using line-pipe,operator should adopt waterproof measure.
- When there's water hammer phenomenon, please aware of valve switching time adjustment and choose the suitable product.
- Operator should make sure that the electric appliance of this valve is higher than line pipe, in order to prevent water from the inflowing electric appliance along line which leads to damaging of machine.

#### Operating

##### Manual operating

- Uninstall manual insert hole cover. Below having lever shaft hexangular hole ( subtense 4mm ).
- Insert socket head wrench to hexagon, "close" is clockwise, "open" is counter-clockwise.
- When electrifying,manual operation is forbidden. When manual operation,must confirm the display on opening meter. To avoid malfunction, when full open and full off, DO NOT use hexagon wrenches to turn forcefully.



#### Electromotion operation

- Before electromotion operation, please use the manual operation method, to confirm the opening meter and valve are in the same position, and make sure the wire connection is correct, then do the electro-motion operation.
- When full open, red LED is on, when full off,green LED is on.

#### Maintenance

- Because use of the molybdenum disulfide lithium-based grease so no need to add oil.
- Work after a long stop,please confirm if the core deflecting and torsion happen,and if it has good slippage.

#### Noted items of indoor installation

- The common product,be installed in the room full of explosive air unless explosion-proof product.
- If installed at certain place having water or splashed material, operator is supposed to install the protection cover additionally for covering complete-machine safely.

#### Noted items of outdoor installation

- Please installing protection cover above complete-machine additionally in order to avoid rain of sunshine ( The shining of sunshine outdoor would lead to high-temperature which accelerates ageing of components,even losing effective. The rain would accelerate aging of rubber-pad, moreover, the product will be damaged if failing in water proof conduction ).
- Operator should save necessary space needed by manual wire-in operation in advance.



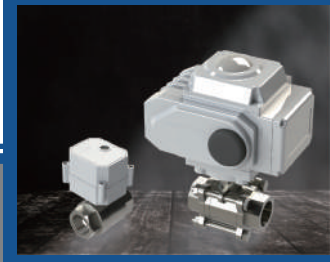

# PRODUCT/ MOTORIZE BALL VALVE

## Electrical Valve Actuator



### Wiring connection

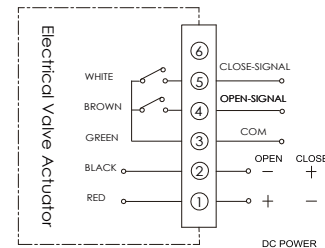
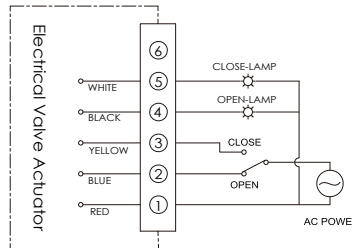

### Specifications Characteristics

Series	ST-05B		ST-10B		ST-20B		ST-40B		ST-60B	
	DC24V	AC110V AC220V	DC24V	AC110V AC220V	DC24V	AC110V AC220V	DC24V	AC110V AC220V	DC24V	AC110V AC220V
Acting range	0 ~ 360°				0 ~ 90°		0 ~ 90°		0 ~ 90°	
Output torque	50Nm		100Nm		200Nm		400Nm		600Nm	
Acting time	7Sec	20Sec	10Sec	30Sec	12Sec	30~60Sec	15Sec	30~60Sec	20Sec	45~60Sec
Rating electricity	0.5A	0.48A 0.24A	0.85A	0.7A 0.32A	1.2A	1.6A 0.88A	2.5A	2.2A 1A	2.5A	2.2A 1A
Motor power	10W	15W	20W	25W	40W	40W	70W	90W	90W	90W
Insulation resistance(MΩ)	100/250 VDC	100/500 VDC	100/250 VDC	100/500 VDC	100/250 VDC	100/500 VDC	100/250 VDC	100/500 VDC	100/250 VDC	100/500 VDC
Voltage resistance rating (1 Minute)	500VAC	1500VAC	500VAC	1500VAC	500VAC	1500VAC	500VAC	1500VAC	500VAC	1500VAC
Use of the environment	Temperature: -25~+55°C ; Humidity: 10~90%RH									
Defend level	IP-67									
Body material	Aluminium die-casting									
Install direction	360 degrees omni-directional									
Electriad connection	Each one or M18*1.5 water-proof cable connectors									
Weight	2.8kg		4.4kg		9.5kg		10kg		10kg	

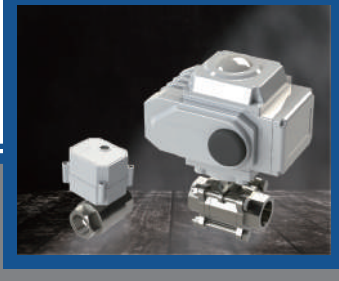

# PRODUCT/ MOTORIZE BALL VALVE

## Installation

- When use DC24V power.no need to partition Anode and cathode.
- Wiring project should carry on by the qualified electric engineer according to the electrical facility technique standard.
- It forbids to do wiring project in rainy day or in high humidity.
- Please confirm wiring connection drawing correct connection.
- This device have special cable, no need interior wiring.
- No-opening the top cover ( Already have cables ).
- When electrifying,absolutely forbid to connect the opening and closing switch at the same time.
- When using line-pipe,operator shouldadopt waterproof measure.
- Operator should make sure that the electric appliance of this valve is higher than line pipe, in order to prevent water from inflowing electric appliance along line which leads to damaging of maching.

## Dimensions ( mm )

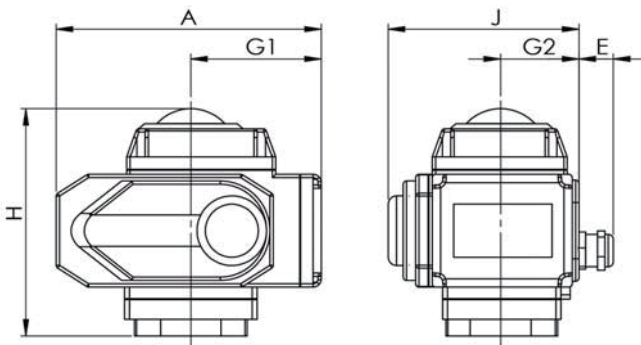
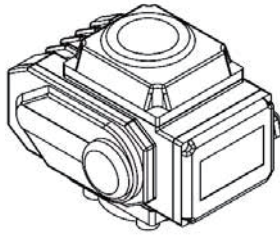

Code No.	A	E	G1	G2	H	J
ST05	160	24	78	50	151	114
ST10	196	24	99	50	170	122
ST20	256	24	135	65	208	156
ST40	256	24	135	65	208	156
ST60	256	24	135	65	208	156

## Maintenance

- Because use of the molybdenum disulfide lithium-based grease, so that no need to add oil.
- Work after a long stop, please confirm if he core-deflecting and torsion happen, and if it has good slippage.

## Noted items of indoor installation

- The common product,be installed in the room full of explosive air unless explosion-proof product.
- If installed at certain place having water or splashed material, operator is supposed to install the protection cover additionally forcovering complete-machine safely.
- Operator should save necessary space needed by manual wire-in operation in advance.

## Noted items of outdoor installation

- Please installing protection cover above complete-machine additionally in order to avoid rain of sunshine ( The shining of sunshine outdoor would lead to high-temperature which accelerates ageing of components,even losing effec-tiven, The rain would accelerate aging of rubber-pad,moreover, the product will be damaged if failing in water proof conduction ).
- Operator should save necessary space needed by manual wire-in operation in advance.

## Operating

### Manual operating

- Uninstall manual insert hole cover. Below having lever shaft hexangular hole ( subtense 4mm ).
- Insert socket head wrench to hexagon, "close" is clockwise, "open" is counter-clockwise.
- When electrifying,manual operation is forbidden, when manual operation,must confirm the display on opening meter. To avoid malfunction,when full open and full off, don't use hexagon wrenches to turn forcefully.

### Electromotion operation

- Before electromotion operation, please use the manual operation method,to confirm the opening meter and valve are in the same position,and make sure the wire connection is correct, then do the electro-motion operation.
- When full open,red LED is on , when full off,green LED is on.

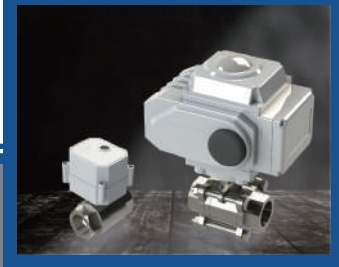

# PRODUCT/ MOTORIZE BALL VALVE

## PVC Motorize 3-Port True Union Ball Valve







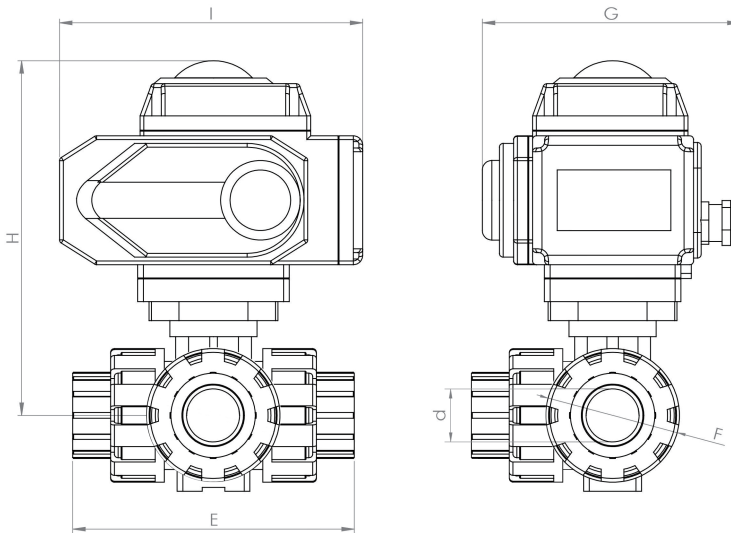

## Specifications Characteristics

Model	2P-E Series
Medium Temp.	-10°C - 80°C
ENV Temp.	-10°C - 60°C
Pressure	0 - 1.0 Mpa
Function	Switch control, Proportional control
Actuator Mat.	Al alloy die casting, Protect level IP-67
Valve body Mat.	UPVC
Valve seat Mat.	EPDM
Operate Direction	L-Type, T-Type
Union spec.	JIS / ANSI / DIN

## Dimensions ( mm )

\* Actuators above the valve are divided into High torque and Low torque, size are different.  
Actual actuator dimension based on the real product.



Angle Port	0°	90°	180°	270°
L-Type				
T-Type				

Body Dimension	d			E	F	G	H	I	Actuator Suggest
	JIS	ANSI	DIN						
1/2"	22	21.53	20	137	54	138	204	160	ST05
3/4"	26	26.87	25	172	69	138	220	160	ST05
1"	32	33.65	32	200	82	138	233	160	ST05
1-1/4"	38	42.41	40	208	82	138	233	160	ST05
1-1/2"	48	48.56	50	240	117	146	268	196	ST05
2"	60	60.62	63	246	117	146	287	196	ST10



# PRODUCT/ MOTORIZE BALL VALVE

## How to select model

**ST 05 B - 2PE L 25 A - AC220V**

Actuator Model		Function		Flow direction		Dimension		Body material		Voltage
Model	Function	Code	Direction	Code	Dimension	Code	Material	Code	Voltage	
05	Switch Type	B	L-Type	L	1/4"	08	UPVC		AC110V	
10	Proportional Type	A	T-Type	T	3/8"	10			AC220V	
					1/2"	15			DC24V	
					3/4"	20				
					1"	25				
					1-1/4"	32		JIS	J	
					1-1/2"	40		ANSI	A	
					2"	50		DIN	D	
									Union spec	
								Union	Code	

\* Actuator Proportional type  
Input / Output signal  
**4 - 20 mA.DC** in factory setting.

If you have different request,  
welcome to discuss with us.

\* Gasket in the valve is **EPDM** in the  
factory setting.  
Suggest working temperature:  
-10°C ~ 80°C

